

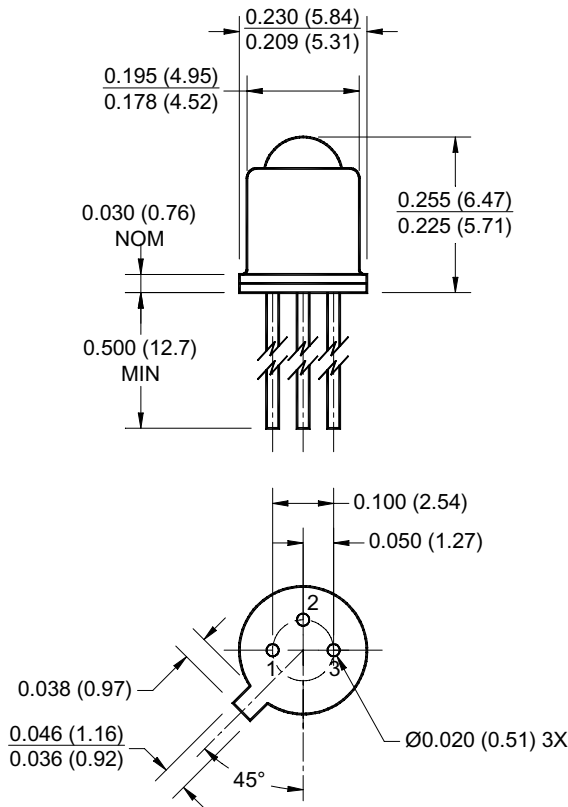

HERMETIC SILICON PHOTODARLINGTON

L14F1 L14F2

PACKAGE DIMENSIONS



NOTES:

1. Dimensions for all drawings are in inches (mm).
2. Tolerance of $\pm .010$ (.25) on all non-nominal dimensions unless otherwise specified.

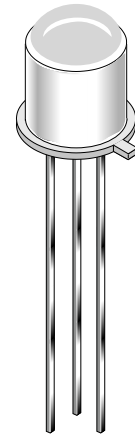

SCHEMATIC

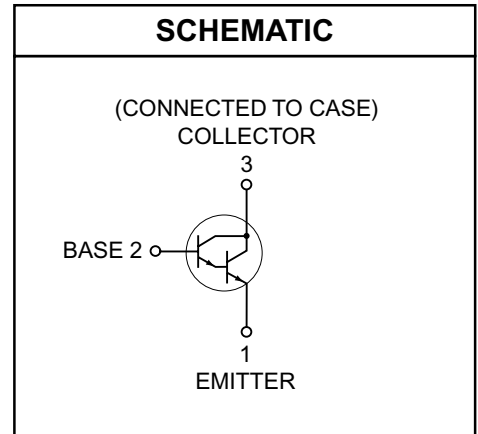

DESCRIPTION

The L14F1/L14F2 are silicon photodarlington mounted in a narrow angle, TO-18 package.

FEATURES

- Hermetically sealed package
- Narrow reception angle

L14F1 L14F2

ABSOLUTE MAXIMUM RATINGS ($T_A = 25^\circ\text{C}$ unless otherwise specified)

Parameter	Symbol	Rating	Unit
Operating Temperature	T_{OPR}	-65 to +125	$^\circ\text{C}$
Storage Temperature	T_{STG}	-65 to +150	$^\circ\text{C}$
Soldering Temperature (Iron) ^(3,4,5 and 6)	T_{SOL-I}	240 for 5 sec	$^\circ\text{C}$
Soldering Temperature (Flow) ^(3,4 and 6)	T_{SOL-F}	260 for 10 sec	$^\circ\text{C}$
Collector to Emitter Breakdown Voltage	V_{CEO}	25	V
Collector to Base Breakdown Voltage	V_{CBO}	25	V
Emitter to Base Breakdown Voltage	V_{EBO}	12	V
Power Dissipation ($T_A = 25^\circ\text{C}$) ⁽¹⁾	P_D	300	mW
Power Dissipation ($T_C = 25^\circ\text{C}$) ⁽²⁾	P_D	600	mW

NOTE:

- Derate power dissipation linearly 3.00 mW/ $^\circ\text{C}$ above 25 $^\circ\text{C}$ ambient.
- Derate power dissipation linearly 6.00 mW/ $^\circ\text{C}$ above 25 $^\circ\text{C}$ case.
- RMA flux is recommended.
- Methanol or isopropyl alcohols are recommended as cleaning agents.
- Soldering iron tip 1/16" (1.6mm) minimum from housing.
- As long as leads are not under any stress or spring tension.
- Light source is a GaAs LED emitting light at a peak wavelength of 940 nm.
- Figure 1 and figure 2 use light source of tungsten lamp at 2870 $^\circ\text{K}$ color temperature. A GaAs source of 0.05 mW/cm² is approximately equivalent to a tungsten source, at 2870 $^\circ\text{K}$, of 0.2 mW/cm².

ELECTRICAL / OPTICAL CHARACTERISTICS ($T_A = 25^\circ\text{C}$) (All measurements made under pulse conditions)

PARAMETER	TEST CONDITIONS	SYMBOL	MIN	TYP	MAX	UNITS
Collector-Emitter Breakdown	$I_C = 10\text{ mA}$, $E_e = 0$	BV_{CEO}	25		—	V
Emitter-Base Breakdown	$I_E = 100\ \mu\text{A}$, $E_e = 0$	BV_{EBO}	12		—	V
Collector-Base Breakdown	$I_C = 100\ \mu\text{A}$, $E_e = 0$	BV_{CBO}	25		—	V
Collector-Emitter Leakage	$V_{CE} = 12\text{ V}$, $E_e = 0$	I_{CEO}	—		100	nA
Reception Angle at 1/2 Sensitivity		θ		± 8		Degrees
On-State Collector Current L14F1	$E_e = .125\text{ mW/cm}^2$, $V_{CE} = 5\text{ V}$ ⁽⁷⁾	$I_{C(ON)}$	7.5		—	mA
On-State Collector Current L14F2	$E_e = .125\text{ mW/cm}^2$, $V_{CE} = 5\text{ V}$ ⁽⁷⁾	$I_{C(ON)}$	2.5			mA
Rise Time	$I_C = 10\text{ mA}$, $V_{CC} = 5\text{ V}$, $R_L = 100\ \Omega$	t_r		300		μs
Fall Time	$I_C = 10\text{ mA}$, $V_{CC} = 5\text{ V}$, $R_L = 100\ \Omega$	t_f		250		μs

L14F1 L14F2

Figure 1. Light Current vs. Collector to Emitter Voltage

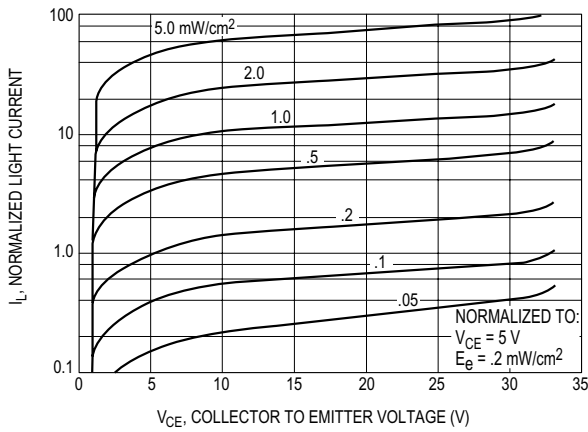

Figure 2. Relative Light Current vs. Ambient Temperature

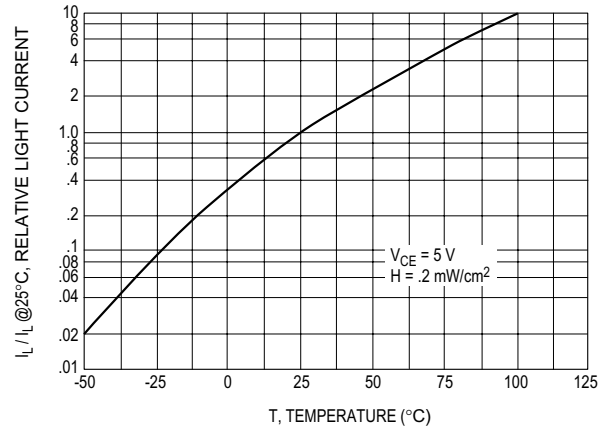

Figure 3. Spectral Response

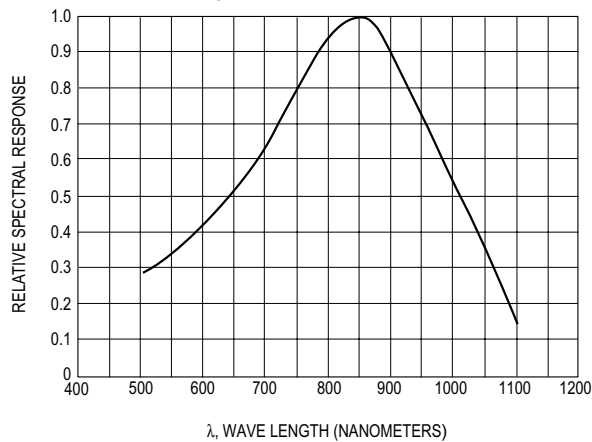

Figure 4. Angular Response

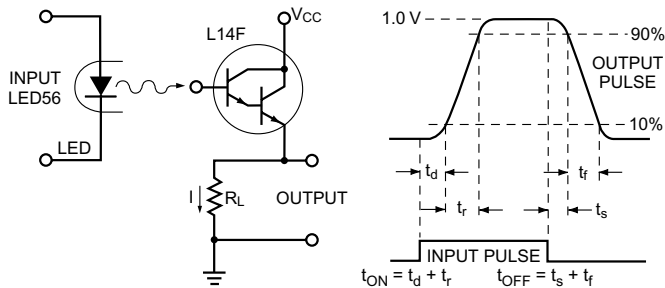
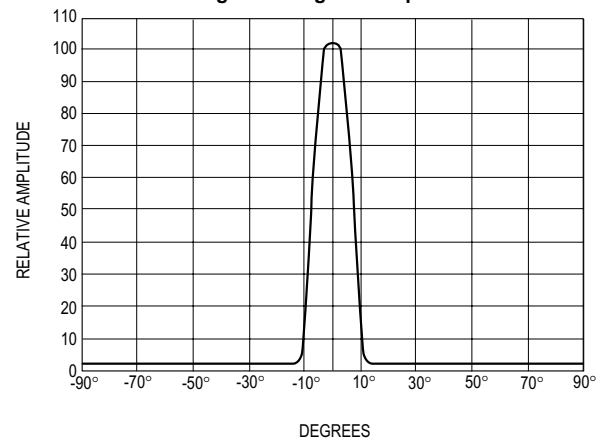
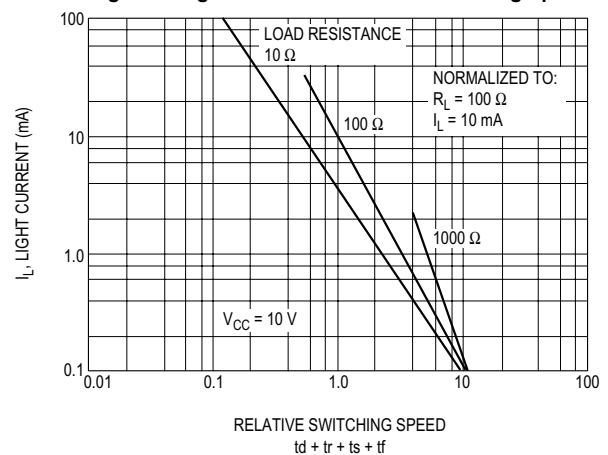

Figure 5. Test Circuit and Voltage Waveforms

Figure 6. Light Current vs. Relative Switching Speed



DISCLAIMER

FAIRCHILD SEMICONDUCTOR RESERVES THE RIGHT TO MAKE CHANGES WITHOUT FURTHER NOTICE TO ANY PRODUCTS HEREIN TO IMPROVE RELIABILITY, FUNCTION OR DESIGN. FAIRCHILD DOES NOT ASSUME ANY LIABILITY ARISING OUT OF THE APPLICATION OR USE OF ANY PRODUCT OR CIRCUIT DESCRIBED HEREIN; NEITHER DOES IT CONVEY ANY LICENSE UNDER ITS PATENT RIGHTS, NOR THE RIGHTS OF OTHERS.

LIFE SUPPORT POLICY

FAIRCHILD'S PRODUCTS ARE NOT AUTHORIZED FOR USE AS CRITICAL COMPONENTS IN LIFE SUPPORT DEVICES OR SYSTEMS WITHOUT THE EXPRESS WRITTEN APPROVAL OF THE PRESIDENT OF FAIRCHILD SEMICONDUCTOR CORPORATION. As used herein:

1. Life support devices or systems are devices or systems which, (a) are intended for surgical implant into the body, or (b) support or sustain life, and (c) whose failure to perform when properly used in accordance with instructions for use provided in labeling, can be reasonably expected to result in a significant injury of the user.
2. A critical component in any component of a life support device or system whose failure to perform can be reasonably expected to cause the failure of the life support device or system, or to affect its safety or effectiveness.